

Anschrift	Bemerkung	
	<input type="radio"/> Angebot	<input type="radio"/> Bestellung
Rollstuhlmodell:		

Das V-Trak Rückensystem ist ein komplett modulares System mit allen notwendigen Bestandteilen passend für einen Rollstuhl mit einem Rohrdurchmesser von 19 mm bis 25 mm (3/4"-1"). Adapter für andere Rohrdurchmesser oder Einzelteile entnehmen Sie bitte den folgenden Seiten.

Maßtabelle der Rückensysteme



AXXIS Profile Rücken			
Artikel-Nr.	Rückenschale (alle Angaben in cm)		
	Breite		Höhe
	max	min	
AXPH-XL	50	41	61
AXPH-L	43	35	61
AXPH-M	38	30	61
AXPS-XL	50	41	40,5
AXPS-L	43	35	40,5
AXPS-M	38	30	40,5
AXPR-XL	50	41	30,5
AXPR-L	43	35	30,5
AXPR-M	38	30	30,5
AXPHR-XL	55	43	53
AXPHR-L	50	38	53
AXPHR-M	44	34	51

AXXIS Deep Contour Rücken			
Artikel-Nr.	Rückenschale (alle Angaben in cm)		
	Breite		Höhe
	max	min	
AXDH-XXL	60	50	61
AXDH-XL	55	43	61
AXDH-L	50	38	61
AXDH-M	44	34	56
AXDS-XXL	60	50	40,5
AXDS-XL	55	43	40,5
AXDS-L	50	38	40,5
AXDS-M	44	34	36
AXDR-XL	55	43	30,5
AXDR-L	50	38	30,5
AXDR-M	44	34	30,5
AXDR-S	40	30	28
AXDHR-XXL	60	50	53
AXDHR-XL	55	43	53
AXDHR-L	50	38	53
AXDHR-M	44	34	51

BITTE WÄHLEN SIE IMMER ZU ALLEN RÜCKENSYSTEMEN DAS MONTAGEMATERIAL AUS!

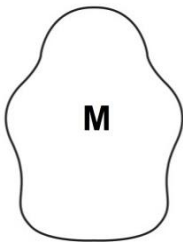
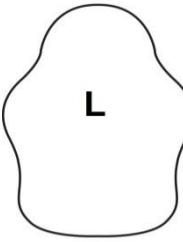

Hoher Axxis Profile Rücken

Ohne Montagematerial

Art.-Nr. € Menge AXPH-M 440,- <input type="text"/> Höhe 610 mm 	Art.-Nr. € Menge AXPH-L 480,- <input type="text"/> Höhe 610 mm 	Art.-Nr. € Menge AXPH-XL 560,- <input type="text"/> Höhe 610 mm 
--	--	---

Niedriger Axxis Profile Rücken

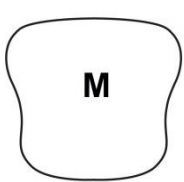
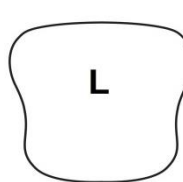
Ohne Montagematerial

Art.-Nr. € Menge AXPS-M 360,- <input type="text"/> Höhe 405 mm 	Art.-Nr. € Menge AXPS-L 400,- <input type="text"/> Höhe 405 mm 	Art.-Nr. € Menge AXPS-XL 480,- <input type="text"/> Höhe 405 mm 
---	--	---

Mittlerer Axxis Profile Rücken

Ohne Montagematerial

Art.-Nr.	€	Menge	Art.-Nr.	€	Menge	Art.-Nr.	€	Menge
AXPHR-M	400,-	<input type="text"/>	AXPHR-L	440,-	<input type="text"/>	AXPHR-XL	520,-	<input type="text"/>
Höhe 510 mm			Höhe 530 mm			Höhe 530 mm		

Segment-Verbindungsscharnier

Art.-Nr.	€	Menge
SH SD	120,-	<input type="text"/>



Reduzierter Axxis Profile Rücken

Ohne Montagematerial

Art.-Nr.	€	Menge	Art.-Nr.	€	Menge	Art.-Nr.	€	Menge
AXPR-M	320,-	<input type="text"/>	AXPR-L	360,-	<input type="text"/>	AXPR-XL	440,-	<input type="text"/>
Höhe 305 mm			Höhe 305 mm			Höhe 350 mm		

Rückenverlängerung

Art.-Nr.	€	Menge
BKXT-M	128,-	<input type="text"/>



Art.-Nr.	€	Menge
BKXT-L	128,-	<input type="text"/>



Segment Axxis Rücken

Art.-Nr.	€	Menge	Art.-Nr.	€	Menge	Art.-Nr.	€	Menge	Art.-Nr.	€	Menge
AXSB-SF	190,-	<input type="text"/>	AXSB-MF	210,-	<input type="text"/>	AXSB-LF	220,-	<input type="text"/>	AXSB-XLF	260,-	<input type="text"/>
Höhe 170 mm (6,75")			Höhe 205 mm (8")			Höhe 205 mm (8")			Höhe 205 mm (8")		
max. Breite 330 mm (13") min. Breite 260 mm (12")			max. Breite 380 mm (15") min. Breite 300 mm (12")			max. Breite 430 mm (17") min. Breite 350 mm (14")			max. Breite 500 mm (20") min. Breite 400 mm (16")		

Segment Axxis Rücken

Art.-Nr.	€	Menge	Art.-Nr.	€	Menge	Art.-Nr.	€	Menge	Art.-Nr.	€	Menge
AXSB-SR	180,-	<input type="text"/>	AXSB-MR	210,-	<input type="text"/>	AXSB-LR	280,-	<input type="text"/>	AXSB-XLR	280,-	<input type="text"/>
Höhe 145 mm (5,75")			Höhe 150 mm (6")			Höhe 160 mm (6,25")			Höhe 170 mm (6,75")		
max. Breite 330 mm (13") min. Breite 260 mm (10")			max. Breite 380 mm (15") min. Breite 300 mm (12")			max. Breite 430 mm (17") min. Breite 350 mm (14")			max. Breite 500 mm (20") min. Breite 400 mm (16")		

Hoher Axxis Deep Contour Rücken

Ohne Montagematerial

Art.-Nr.	€	Menge	Art.-Nr.	€	Menge	Art.-Nr.	€	Menge
AXDH-M	480,-	<input type="text"/>	AXDH-L	540,-	<input type="text"/>	AXDH-XL	580,-	<input type="text"/>
Höhe 560mm			Höhe 610mm			Höhe 610mm		
Konturtiefe 10 - 15cm			Konturtiefe 10 - 15cm			Konturtiefe 10 - 15cm		

Niedriger Axxis Deep Contour Rücken

Ohne Montagematerial

Art.-Nr.	€	Menge	Art.-Nr.	€	Menge	Art.-Nr.	€	Menge
AXDS-M	400,-	<input type="text"/>	AXDS-L	460,-	<input type="text"/>	AXDS-XL	500,-	<input type="text"/>
Höhe 360mm			Höhe 400mm			Höhe 400mm		
Konturtiefe 10 - 15 cm			Konturtiefe 10 - 15cm			Konturtiefe 10 - 15cm		

Die Preise verstehen sich als empf. Verkaufspreise zzgl. der gültigen Mehrwertsteuer.

Änderungen und Irrtümer vorbehalten. Es gelten unsere Liefer- und Zahlungsbedingungen

Mittlere Axxis Deep Contour Rücken

Ohne Montagematerial

Art.-Nr.	€	Menge	Art.-Nr.	€	Menge	Art.-Nr.	€	Menge	Art.-Nr.	€	Menge	Art.-Nr.	€	Menge	Art.-Nr.	€	Menge
AXDHR-M	440,-	<input type="text"/>	AXDHR-L	500,-	<input type="text"/>	AXDHR-XL	540,-	<input type="text"/>	AXDH-XXL	620,-	<input type="text"/>	AXDS-XXL	610,-	<input type="text"/>	AXDHR-XXL	600,-	<input type="text"/>
Höhe 510mm			Höhe 530mm			Höhe 530mm			Höhe 610mm			Höhe 405mm			Höhe 530mm		

Reduzierter Axxis Deep Contour Rücken

Ohne Montagematerial

Art.-Nr.	€	Menge	Art.-Nr.	€	Menge	Art.-Nr.	€	Menge	Art.-Nr.	€	Menge
AXDR-S	320,-	<input type="text"/>	AXDR-M	360,-	<input type="text"/>	AXDR-L	420,-	<input type="text"/>	AXDR-XL	460,-	<input type="text"/>
Höhe 280mm			Höhe 305mm			Höhe 305mm			Höhe 305mm		

Segment Axxis Deep Contour

Art.-Nr.	€	Menge	Art.-Nr.	€	Menge
AXSBD-SF	230,-	<input type="text"/>	AXSBD-MF	230,-	<input type="text"/>
Höhe 170mm			Höhe 250mm		
max. Breite 330mm			max. Breite 450mm		
min. Breite 265mm			min. Breite 340mm		

Segment Axxis Deep Contour

Art.-Nr.	€	Menge	Art.-Nr.	€	Menge	Art.-Nr.	€	Menge	Art.-Nr.	€	Menge	Art.-Nr.	€	Menge	Art.-Nr.	€	Menge
AXSBD-LF	260,-	<input type="text"/>	AXSBD-XLF	260,-	<input type="text"/>	AXSBD-SR	260,-	<input type="text"/>	AXSBD-MR	230,-	<input type="text"/>	AXSBD-LR	260,-	<input type="text"/>	AXSBD-XLR	260,-	<input type="text"/>
Höhe 250mm			Höhe 250mm			Höhe 145mm			Höhe 150mm			Höhe 160mm			Höhe 170mm		
max. Breite 500mm			max. Breite 550mm			max. Breite 330mm			max. Breite 450mm			max. Breite 500mm			max. Breite 550mm		
min. Breite 380mm			min. Breite 430mm			min. Breite 265mm			min. Breite 340mm			min. Breite 380mm			min. Breite 430mm		

Maßstabelle der Rückensysteme

AXXIS Rücken					
Artikel-Nr.	Rückenschale (alle Angaben in cm)				
	Breite außen (OW)		Breite innen (IW)		Höhe
	max	min	max	min	
AXH-XL	50	41	43	35	61
AXS-XL	50	41	43	35	40
AXR-XL	50	41	43	35	30
AXR-S	33	26	30	24	28



Hoher Axxis Rücken

Niedriger Axxis Rücken

Reduzierter Axxis Rücken

Ohne Montagematerial

Art.-Nr.	€	Menge
AXH-XL	540,-	<input type="text"/>

Art.-Nr.	€	Menge
AXS-XL	420,-	<input type="text"/>

Art.-Nr.	€	Menge
AXR-S	320,-	<input type="text"/>

Art.-Nr.	€	Menge
AXR-XL	420,-	<input type="text"/>

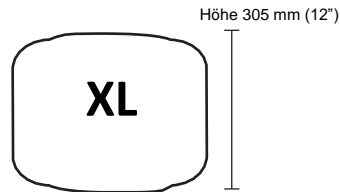
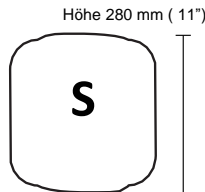
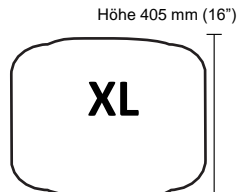
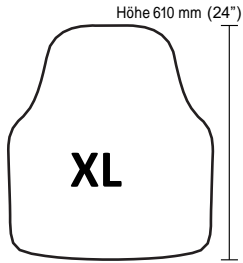

Montagematerial

Standard Halterung

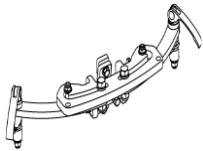

Artikel-Nr.	Beschreibung	Mögl. Breite	Empf. für Rollstuhlbreite	€	Menge
CMA100	Rückenhalterung mit 100mm Armlänge	24,5-41,5cm	28 / 30 / 33 / 36 cm	295,00	
CMA125	Rückenhalterung mit 125mm Armlänge	28,5-46cm	38 cm	295,00	
CMA150	Rückenhalterung mit 150mm Armlänge	32,5-49,5cm	41 / 43 cm	295,00	
CMA175	Rückenhalterung mit 170mm Armlänge	37-52,5 cm	46 cm	295,00	
CMA200	Rückenhalterung mit 200mm Armlänge	40-57,5 cm	48 / 51 cm	295,00	
CMA225	Rückenhalterung mit 225mm Armlänge	43-61 cm	53 cm	295,00	
CMA250	Rückenhalterung mit 250mm Armlänge	49-67 cm	56 / 58 / 61 cm	295,00	

ODER

Lite Halterung

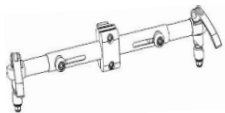

Artikel-Nr.	Beschreibung	Breite	€	Menge
VL PS	Lite" Zentrale Halterung rund, gerade, small	27-33 cm	215,00	
VL PM	Lite" Zentrale Halterung rund, gerade, medium	32-36 cm	215,00	
VL AS	Lite" Zentrale Halterung rund, gebogen, small	38-41 cm	215,00	
VL AM	Lite" Zentrale Halterung rund, gebogen, medium	43-46 cm	215,00	
VL AL	Lite" Zentrale Halterung rund, gebogen, large	47-51 cm	215,00	
VL AXL	Lite" Zentrale Halterung rund, gebogen, X-large	Ab 52 cm	215,00	

+

Universeller seitlicher Montageblock



Artikel-Nr.	Beschreibung	€	Menge
MB-R-UE	Universal-Halteblock (Paar)	175,00	
MB-R-16	Montage-Block für 16 mm Rohr - Sopur	175,00	

Weitere Halteblöcke für unterschiedliche Rollstuhlmodelle auf Anfrage.



NEU!

Quick Release Halterung



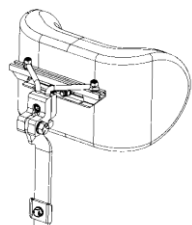
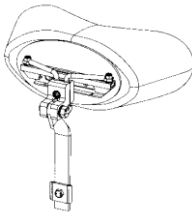

Artikel-Nr.	Beschreibung	€	Menge
VTQ20	Quick Release Halterung 20mm Durchmesser zur Befestigung direkt am Stabilisierungsbügel vom Rollstuhl	245,00	
VTQ22	Quick Release Halterung 20mm Durchmesser zur Befestigung an der V-Trak Lite Halterung oder direkt am Stabilisierungsbügel vom Rollstuhl	245,00	



V-Trak Kopfstütze

	3-fach verstellbar, mit Styropor-Kissen	Art.-Nr. HS SC	€ 180,-	Menge <input type="text"/>		6-fach verstellbar, gebogene Form	Art.-Nr. HS AW	€ 315,-	Menge <input type="text"/>
	6-fach verstellbar, mit Styropor-Kissen	Art.-Nr. HS AC	€ 290,-	Menge <input type="text"/>		6-fach verstellbar, breit, gebogene Form	Art.-Nr. HS AWL	€ 325,-	Menge <input type="text"/>

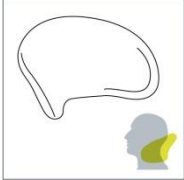

Kopfstützenzubehör

	Kopfstützenadapter für 14 mm ø Vierkant-Rohr	Art.-Nr. HA 14	€ 110,-	Menge <input type="text"/>		Schienen- Verlängerung	Art.-Nr. BM HX	€ 95,-	Menge <input type="text"/>
	Kopfstützenadapter für 17 mm ø Vierkant-Rohr	Art.-Nr. HA 17	€ 110,-	Menge <input type="text"/>		Bitte mitbestellen!			
	Kopfstützenadapter für 20 mm ø Vierkant-Rohr	Art.-Nr. HA 20	€ 110,-	Menge <input type="text"/>					

X-Tend Kopfstützensystem

	X-Tend Kopfstützen Verbindungsstück mit Quick Release Befestigung	Art.-Nr. HIXQ	€ 315,-	Menge <input type="text"/>		X-Tend Kopfstütze (halbmondförmig)	Art.-Nr. HPCR	€ 195,-	Menge <input type="text"/>
	X-Tend Kopfstütze (sichelförmig)	Art.-Nr. HPCMW	€ 195,-	Menge <input type="text"/>					

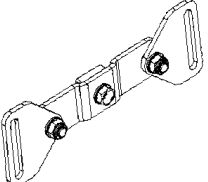
V-Trak Zubehör

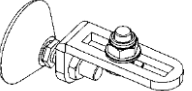
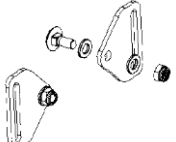
	Gurthalter für 4-Punkt-Gurt (1 Paar)	Art.-Nr. BM AHC	€ 120,-	Menge <input type="text"/>		Schalenstabilisator erweitert (1 Paar)	Art.-Nr. BM STX	€ 115,-	Menge <input type="text"/>
	Schalenstabilisator (1 Paar)	Art.-Nr. BM STA	€ 81,-	Menge <input type="text"/>		Gurthalterung für Zusatzbefestigungsarm	Art.-Nr. BM AHK	€ 50,-	Menge <input type="text"/>

V-Trak Zubehör

Zusatzbestigungsarm mit Gurt

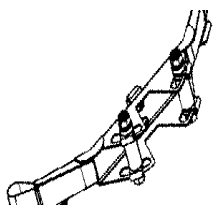
	Art.-Nr.	€	Menge
 Passend für Rücken bis Sitzbreite 37,5 cm	BM SPS	105,-	<input type="text"/>
Passend für Rücken bis Sitzbreite 41 cm	BM SAS 15	160,-	<input type="text"/>
Passend für Rücken bis Sitzbreite 50 cm	BM SAS 17	160,-	<input type="text"/>

	Art.-Nr.	€	Menge
 Halter für Seitenpelotten rechts	TS2 RH	285,-	<input type="text"/>
Halter für Seitenpelotte links	TS2 LH	285,-	<input type="text"/>

Pelottenplatten

	Art.-Nr.	€	Menge
 Polsterplatte mit Bezug Standard, links (140 x 100 mm)	TS2 MPL	95,-	<input type="text"/>

Pelottenplatte mit Bezug Standard, rechts (140 x 100 mm)	TS2 MPR	95,-	<input type="text"/>
--	----------------	------	----------------------

 Pelottenplatte mit Bezug groß, links (170 x 120 mm)	TS2 LPL	95,-	<input type="text"/>
---	----------------	------	----------------------

Pelottenplatte mit Bezug groß, rechts (170 x 120 mm)	TS2 LPR	95,-	<input type="text"/>
--	----------------	------	----------------------

Ersatzbezüge

Ersatzbezüge für alle Rücken und Kopfstützen. Für Ihre Bestellung fügen Sie einfach vor die Artikel-Nr. die Buchstaben **CV**. Um einen neuen Bezug z.B. für einen mittleren, niedrigen Axxis-Rücken (AXS-M) zu bestellen, gilt folgende Bestell-Nummer: **CV-AXS-M**.

Ersatzbezüge für alle Rücken 95,-

Art.-Nr.	Menge	Art.-Nr.	Menge
CV- _____	<input type="text"/>	CV- _____	<input type="text"/>
CV- _____	<input type="text"/>	CV- _____	<input type="text"/>
CV- _____	<input type="text"/>	CV- _____	<input type="text"/>